

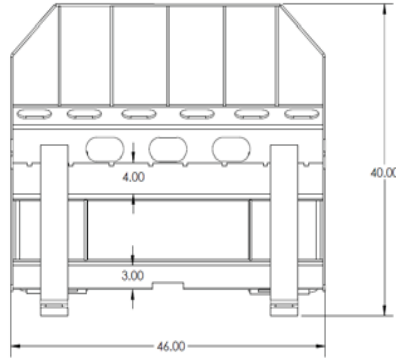

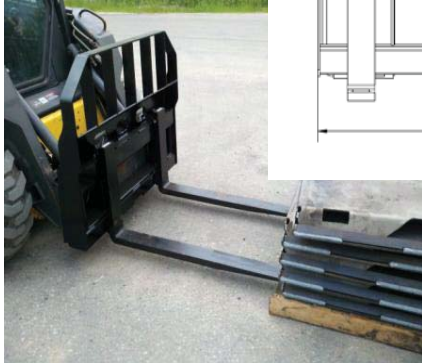



Heavy Duty Pallet Forks

Model# 33019-48



Specifications	
Overall Width	46"
Overall Height	40"
Depth	9½"
Top and Bottom Rails	1/2" Grade 50
Fork Length	48"
Fork Width	4"
Fork Thickness	1-3/8"
Tines	Class II Part #80489
Estimated Load Capacity at 24" Load Center (per pair)	4,400 lbs
Weight	525 lbs

-  Heavy Duty Brick Guard allows for clear vision of load
-  Ideal for moving materials around the job side
-  Built to perform and outlast the competition

Designed for use with palletized material only.

Lift limit is determined by fork capacity or loader capacity, whichever is less.

Capacity is based on no more than 1/2 load per fork and load no more than 1/2 way out on each fork.

Heavy Duty Walk-Thru Pallet Forks

Model #33019-48W

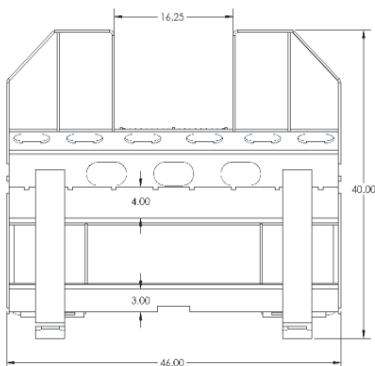

Specifications	
Overall Width	46"
Overall Height	40"
Depth	9½"
Top and Bottom Rails	1/2" Grade 50
Fork Length	48"
Fork Width	4"
Fork Thickness	1-3/8"
Tines	Class II Part #80489
Estimated Load Capacity at 24" Load Center (per pair)	4,400 lbs
Weight	525 lbs







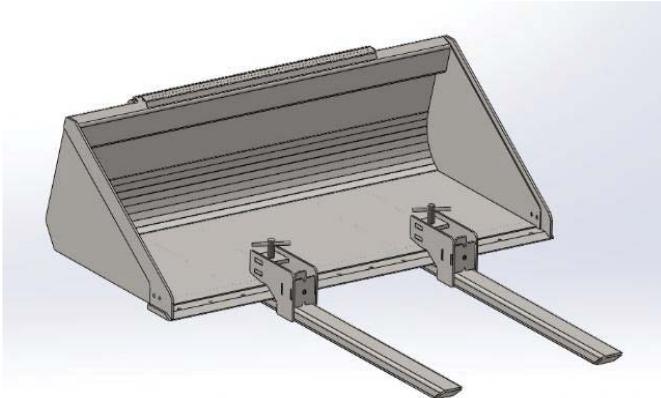

Clamp-On Pallet Forks

Model #33179



Bucket Not Included

-  Durable construction for years of use
-  Easy on/off design for added convenience
-  Mounts to most loader buckets without tools
-  Built-in stake pocket for a 2 x 4 to be installed as an upright backstop
-  Easy adjustment to any pallet width
-  Built-in stake pocket for a 2 x 4 to be installed as an upright backstop

Specifications	
Lift Capacity (Per Set of 2 Pallet Forks)	2,000 lbs.
Overall Tine Length	41-1/4"
Tine Width	4"
Tine Height	2"
Threaded Clamp Rod	1-6 acme
Throat Opening	1-3/8"
Throat Depth	8"
Weight Each	61 lbs.

Designed for use with palletized material only.

Lift limit is determined by fork capacity or loader capacity, whichever is less.

Capacity is based on no more than 1/2 load per fork and load no more than 1/2 way out on each fork.



PALLET FORKS		RETAIL	WEIGHT
33019	Frame Only	\$923.00	225
33019-48	48" HD Pallet Fork - 4400 lb. Lift Capacity	\$1,626.00	500
33019-48X	48" HD Pallet Fork - 5500 lb. Lift Capacity	\$1,728.00	520
33019-60X	60" HD Pallet Fork - 5500 lb. Lift Capacity	\$1,859.00	550
33019-48W	48" HD Walk-Thru Pallet Fork - 4400 lb. Lift Capacity	\$1,626.00	500
33019-48W-X	48" HD Walk-Thru Pallet Fork - 5500 lb. Lift Capacity	\$1,728.00	520
33019-60W-X	60" HD Walk-Thru Pallet Fork - 5500 lb. Lift Capacity	\$1,859.00	550
33106-48W	72" HD Walk-Thru Pallet Fork- 4400 Lb. Lift Capacity	\$2225.00	600
33106-48W-X	72" HD Walk-Thru Pallet Fork - 5500 Lb. Lift Capacity	\$2315.00	620
33106-60W-X	72" HD Walk-Thru Pallet Fork - 5500 Lb. Lift Capacity	\$2444.00	650
33179	Bucket Clamp-On Pallet Forks (set)	\$516.00	61
33287	Pallet Fork Clamp-On Trailer Mover	\$84.00	11



HEAVY DUTY PALLET FORKS



HEAVY DUTY WALK THRU PALLET FORKS



CLAMP ON PALLET FORKS



Pallet Fork Trailer Mover





PALLET FORKS		RETAIL	WT.
90001	45" Standard Duty Pallet Forks - 4400 Lb. Lift Capacity	\$1342.00	385
90001W	45" Standard Duty Walk-Thru Pallet Forks— 4400 lb. Lift Capacity	\$1342.00	385
90001F	45" Wide Standard Duty - Frame Only	\$793.00	195
90001WF	45" Wide Standard Duty - Frame Only - Walk thru	\$800.00	190
80489	Fork Tine - 48" 4400 lb Lift Capacity (2 needed)	\$376.00	102
83801	Fork Tine - 48" 5500 lb Lift Capacity (2 needed)	\$412.00	120
87132	Fork Tine - 60" 5500 lb Lift Capacity (2 needed)	\$504.00	132
33105	Dingo Pallet Forks - 42" 2200 lb. Lift Capacity	\$675.00	
33314	Fork Extensions - 78" long	\$467.00	



STANDARD DUTY
WALK THRU PALLET FORKS